

DIN 2641

Bridas locas para tubo rebordado. Aros lisos.
Presion nominal 6

Lapped flanges Plain collars
Rated pressure 6

Lose Flansche Vorschweißbördel Glatte Bunde
Nenndruck 6

F=Brida loca (Representado con tubo rebordado)
F=Loose Flange
F=Loser Flansch (Dargestell mit gebordeltem Rohr)

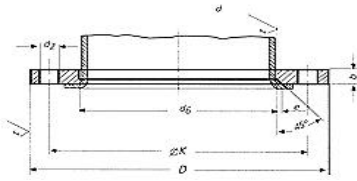

$z = \sqrt{R_2 = 160}$
torneado
turning
gedreht
 $y = \sqrt{R_2 = 160}$

B=Aro liso (Representado con brida loca F)
B=Plain collars
B=Glatte Bund (Dargestellt mit losem Flansch F)

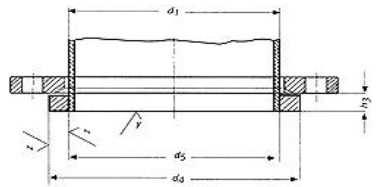

$z = \sqrt{R_2 = 160}$
torneado
turning
gedreht
 $y = \sqrt{R_2 = 160}$

G=Borde de soldadura a tope (Representado con brida loca F)
G=Welding edge
G=Vorschweißbördel (Dargestellt mit losem Flansch F)

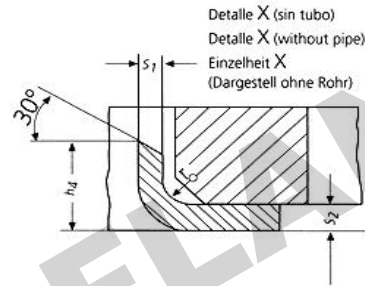
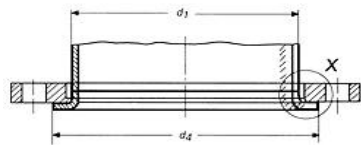

Diámetro Nominal Rated Diameter Diameter Nennweite	d1		Brida / Flange / Flansch					Tornillos / Screws / Schrauben		Aro y borde / Ring / Bund und Bördel							Peso de una brida / Weight of a flange / Gewicht eines Flansches (7,85 Kg/dm3) Kg		
	ISO Serie 1	DIN Serie 2	D	d6	b	k	e	Numero / Number / Anzahl	Rosca / Thread / Gewinde	d2	d5	h3	d4 max.	h4 min.	s1 min.	s2 min.	r	Brida / Flange / Flansch	Aro / Ring / Bund
10	-	14	75	16	10	50	2	4	M 10	11	14,5	8	35	9	1,8	3	2	0,298	0,051
	17,2	-		19							17,7								
15	-	20	80	22	10	55	2	4	M 10	11	21	8	40	9	2	3	2	0,337	0,063
	21,3	-		24							22								
20	-	25	90	28	10	65	2	4	M 10	11	26	10	50	12	2	3	2	0,418	0,116
	26,9	-		30							27,6								
25	-	30	100	33	12	75	3	4	M 10	11	31	10	60	15	2	3	3	0,62	0,166
	33,7	-		36							34,4								
32	-	38	120	42	12	90	3	4	M 12	14	39	10	70	15	2,6	3,5	3	0,874	0,213
	42,4	-		46							43,1								
40	-	44,5	130	50	12	100	3	4	M 12	14	45,5	10	80	17	2,6	3,5	3	1,01	0,273
	48,3	-		54							49								
50	-	57	140	62	12	110	3	4	M 12	14	58,1	12	90	23	2,6	3,5	3	1,12	0,359
	60,3	-		65							61,1								
65	76,1	-	160	81	12	130	3	4	M 12	14	77,1	12	110	23	2,6	3,5	3	1,35	0,468
80	88,9	-	190	94	14	150	3	4	M 16	18	90,3	14	128	23	3,2	4	3	2,24	0,73
100	-	108	210	113	14	170	3	4	M 16	18	109,6	14	148	28	3,2	4	3	2,59	0,884
	114,3	-		119							115,9								
125	-	133	240	138	14	200	3	8	M 16	18	134,8	14	178	30	3,2	4	3	3,1	1,21
	139,7	-		145							141,6								
150	-	159	265	164	14	225	3	8	M 16	18	161,1	14	202	30	3,2	4	3	3,52	1,34
	168,3	-		173							170,5								
200	219,1	-	320	225	16	280	3	8	M 16	18	221,8	16	258	30	3,2	4	3	4,98	2
250	-	267	375	273	20	335	3	12	M 16	18	270,2	18	312	30	4	5	3	7,67	2,89
	273	-		279							276,2								
300	323,9	-	440	329	24	395	4	12	M20	22	327,6	18	365	35	4	5	4	12,3	3,56
350	355,6	-	490	362	26	445	4	12	M 20	22	359,7	18	415	-	-	-	4	15,1	4,08
	-	368		374							372,2								
400	406,4	-	540	413	28	495	4	16	M20	22	411	20	465	-	-	-	4	17,7	4,91
	-	419		426							423,7								
(450)	457	-	595	467	30	550	4	16	M20	22	462,5	20	520	-	-	-	4	20,4	5,7
500	508	-	645	517	32	600	4	20	M20	22	513,6	22	570	-	-	-	4	25,4	7,39
600	610	-	755	618	36	705	4	20	M24	26	616,6	22	670	-	-	-	4	36,3	8,6
700	711	-	860	721	40	810	4	24	M 24	26	718,6	24	775	-	-	-	4	48,1	14
800	813	-	975	824	44	920	4	24	M27	30	821,5	24	880	-	-	-	4	66,5	16,8
900	914	-	1075	926	48	1020	4	24	M27	30	923,5	26	980	-	-	-	4	81,3	20,1
1000	1016	-	1175	1028	52	1120	4	28	M27	30	1027	26	1080	-	-	-	4	96,4	21,5
1200	1220	-	1405	1232	60	1340	5	32	M 30	33	1233	28	1295	-	-	-	5	158	32,6

DIN 2642

Bridas locas para tubo rebordado. Aros lisos.
Presion nominal 10

Lapped flanges Plain collars
Rated pressure 10

Lose Flansche Vorschweißbördel Glatte Bunde
Nenndruck 10

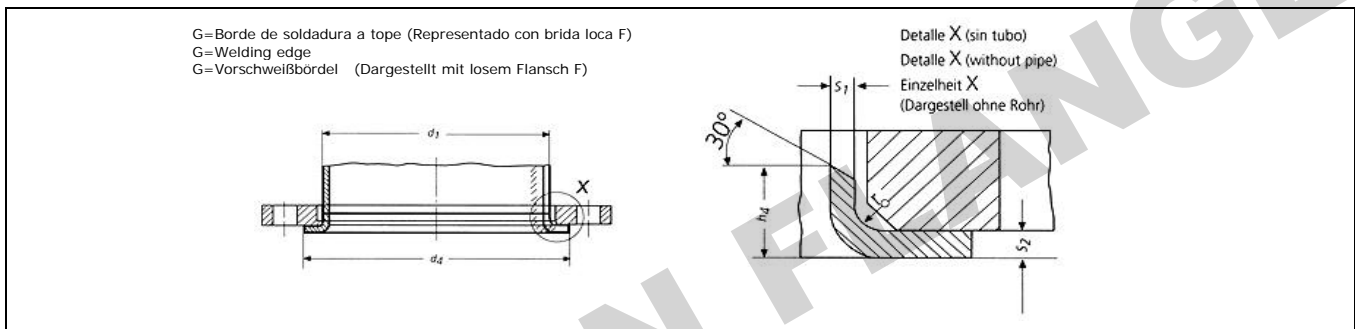
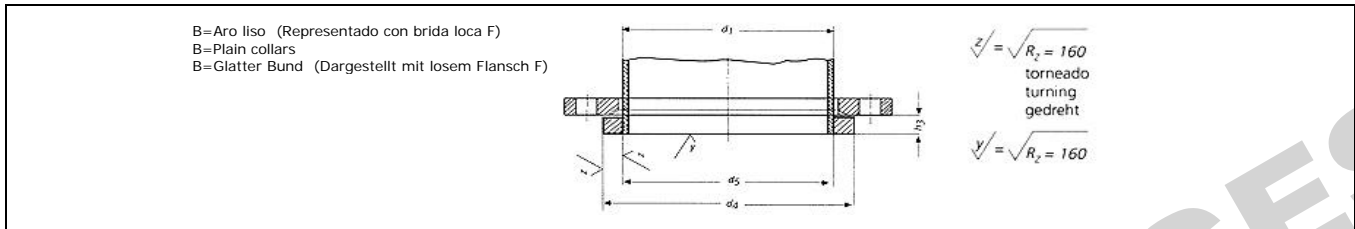
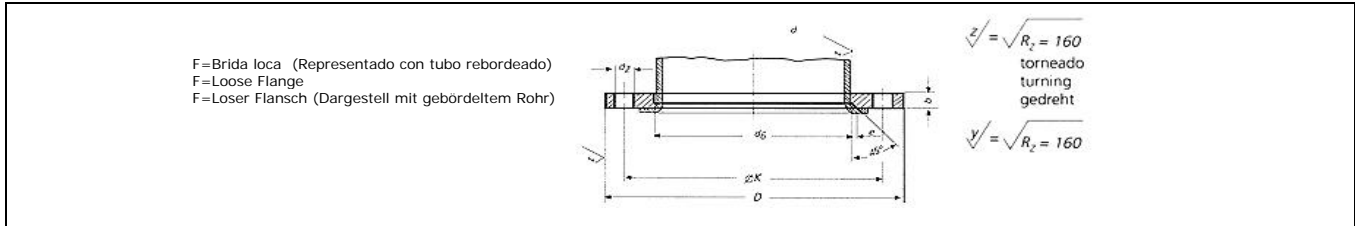

Tubo / Pipe / Rohr - Anschließmabe		Brida / Flange / Flansch						Tornillos / Screws / Schrauben		Aro y borde / Ring / Bund und Bördel							Peso de una brida / Weight of a flange / Gewicht eines Flansches (7,85 Kg/dm ³) Kg		
Diámetro Nominal Rated Diameter Nennweite	d1		D	d6	b	k	e	Numero / Number / Anzahl	Rosca / Thread / Gewinde	d2	d5	h3	d4 max.	h4 min.	s1 min.	s2 min.	r	Brida / Flange / Flansch	Aro / Ring / Bund
	ISO Serie 1 Reihe 1	DIN Serie 2 Reihe 2																	
10	-	14	90	16	14	60	3	4	M 12	14	14,5	10	40	9	1,8	3	3	0,599	0,087
	17,2	-		17,7															
15	-	20	95	22	14	65	3	4	M 12	14	21	10	45	9	2	3	3	0,689	0,105
	21,3	-		22															
20	-	25	105	28	14	75	3	4	M 12	14	26	12	58	12	2	3	3	0,806	0,203
	26,9	-		27,6															
25	-	30	115	33	16	85	4	4	M 12	14	31	12	68	15	2	3	4	1,11	0,276
	33,7	-		34,4															
32	-	38	140	42	16	100	4	4	M 16	18	39	12	78	15	2,6	3,5	4	1,64	0,343
	42,4	-		43,1															
40	-	44,5	150	50	16	110	4	4	M 16	18	45,5	12	88	17	2,6	3,5	4	1,86	0,426
	48,3	-		49															
50	-	57	165	62	16	125	5	4	M 16	18	58,1	14	102	23	2,6	3,5	5	2,2	0,618
	60,3	-		61,1															
65	76,1	-	185	81	16	145	5	4	M 16	18	77,1	14	122	23	2,6	3,5	5	2,62	0,786
80	88,9	-	200	94	18	160	5	8	M 16	18	90,3	16	138	23	3,2	4	5	3,32	1,1
100	-	108	220	113	18	180	5	8	M 16	18	109,6	16	158	28	3,2	4	5	3,67	1,31
	114,3	-		115,9															
125	-	133	250	138	18	210	5	8	M 16	18	134,8	18	188	30	3,2	4	5	4,54	1,96
	139,7	-		141,6															
150	-	159	285	164	18	240	5	8	M 20	22	161,1	18	212	30	3,2	4	5	5,6	2,18
	168,3	-		170,5															
200	219,1	-	340	225	20	295	5	8	M 20	22	221,8	20	268	30	3,2	4	5	7,46	3,1
250	-	267	395	273	22	350	5	12	M 20	22	270,2	22	320	30	4	5	5	10,3	4,22
	273	-		276,2															
300	323,9	-	445	329	26	400	5	12	M 20	22	327,6	22	370	35	4	5	5	14	4,85
350	-	355,6	505	362	28	460	6	16	M 20	22	359,7	22	430	-	-	-	6	18,5	6,71
	-	368		374															
400	-	406,4	565	413	32	515	6	16	M 24	26	411	24	482	-	-	-	6	25	8,28
	-	419		423,7															
(450)	457	-	615	467	38	565	6	20	M 24	26	462,5	24	532	-	-	-	6	30,6	9,3
500	508	-	670	517	38	620	6	20	M 24	26	513,6	26	585	-	-	-	6	37	11,5
600	610	-	780	618	44	725	7	20	M 27	30	616,6	26	685	-	-	-	7	56,3	15,6
700	711	-	895	721	50	840	7	24	M 27	30	718,6	28	800	-	-	-	7	80,4	23,2
800	813	-	1015	824	56	950	7	24	M 30	33	821,5	30	905	-	-	-	7	113,2	29,2