

**Dimensions of PN 16 Flanges DIN EN 1092-1**

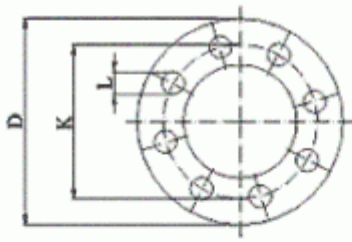

Not shown are Typ 02 in 35,  
Typ 02 in 36, Typ 02 in 37



Typ 01

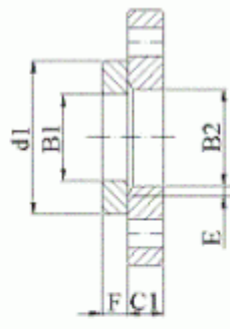

Typ 02 in 32

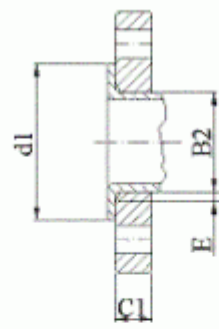

Typ 02 in 33

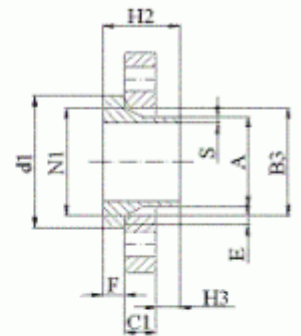

Typ 04 in 34

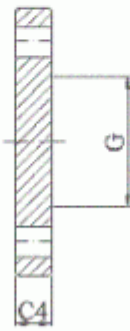

Typ 05

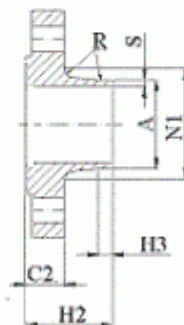

Typ 11

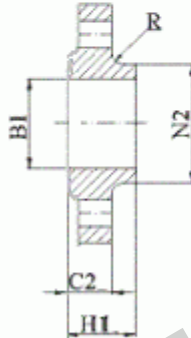

Typ 12



Typ 13



Typ 21

**NOTE 1:** Dimensions N1, N2 and N3 are measured at the intersection of the hub draft angle and the back face of the flange.

**NOTE 2:** For d1 dimensions see document "Flange facing according to DIN EN 1092-1".

Dimensions in mm

Nominal diameter DN	Mating dimensions					Outside diameter of neck	Bore diameters			Flange thickness				Chamfer	Collar thickness		Diameter of shoulders	Length			Neck diameters			Corner radius	Neck thickness (preferred value)																			
	Outside diameter	Diameter of bolt circle	Diameter of bolt hole	Bolting																																								
	D	K	L	No	Size																					A	B1	B2	B3	C1	C2	C3	C4	E	F	G max.	H1	H2	H3	N1	N2	N3	R	S
	Flange Type																																											
01, 02, 05, 11, 12, 21					11 21* 34	01 12 32	02	04	01 02 04	11 12 13	21	05	02 04	32 34	05	12 13	11 34	11 34	11 34	11 34	12 13	21	11 12 13 21	11 34																				
10	Use PN 40 dimensions																																											
15	Use PN 40 dimensions																																											
20	Use PN 40 dimensions																																											
25	Use PN 40 dimensions																																											
32	Use PN 40 dimensions																																											
40	Use PN 40 dimensions																																											
50	165	125	18	4	M16	60,3	61,5	65	77	19	18	18	18	5	16	-	28	45	8	74	84	84	5	2,9																				
65	185	145	18	**	M16	76,1	77,5	81	96	20	18	18	18	6	16	55	32	45	10	92	104	104	6	2,9																				
80	200	160	18	8	M16	88,9	90,5	94	108	20	20	20	20	6	16	70	34	50	10	105	118	120	6	3,2																				
100	220	180	18	8	M16	114,3	116,0	120	134	22	20	20	20	6	18	90	40	52	12	131	140	140	8	3,6																				
125	250	210	18	8	M16	139,7	141,5	145	162	22	22	22	22	6	18	115	44	55	12	156	168	170	8	4,0																				
150	285	240	22	8	M20	168,3	170,5	174	188	24	22	22	22	6	20	140	44	55	12	184	195	190	10	4,5																				
200	340	295	22	12	M20	219,1	221,5	226	240	26	24	24	24	6	20	190	44	62	16	235	246	246	10	5,9																				
250	405	355	26	12	M24	273,0	276,5	281	294	29	26	26	26	8	22	235	46	70	16	292	298	296	12	6,3																				
300	460	410	26	12	M24	323,9	327,5	333	348	32	28	28	28	8	24	285	46	78	16	344	350	350	12	7,1																				
350	520	470	26	16	M24	355,6	359,0	365	400	35	30	30	30	8	26	330	57	82	16	390	400	410	12	8,0																				
400	580	525	30	16	M27	406,4	411,0	416	454	38	32	32	32	8	28	380	63	85	16	445	456	458	12	8,0																				
450	640	585	30	20	M27	457,0	462,0	467	500	42	40	40	40	8	30	425	68	87	16	490	502	516	12	8,0																				
500	715	650	33	20	M30	508,0	513,5	510	556	46	44	44	44	8	32	475	73	90	16	548	559	576	12	8,0																				
600	840	770	36	20	M33	610,0	616,5	622	660	52	54	54	54	8	32	575	83	95	18	652	658	690	12	8,8																				
700	910	840	36	24	M33	711,0	-	-	-	-	36	42	48	-	-	670	83	100	18	755	760	760	12	8,8																				
800	1025	950	39	24	M36	813,0	-	-	-	-	38	42	52	-	-	770	90	105	20	855	864	862	12	10,0																				
900	1125	1050	39	28	M36	914,0	-	-	-	-	40	44	58	-	-	860	94	110	20	955	968	962	12	10,0																				
1000	1255	1170	42	28	M39	1016,0	-	-	-	-	42	46	64	-	-	960	100	120	22	1058	1072	1076	16	10,0																				
1200	1485	1390	48	32	M45	1219,0	-	-	-	-	48	52	76	-	-	1160	-	130	30	1262	-	1282	16	12,5																				
1400	1685	1590	48	36	M45	1422,0	-	-	-	-	52	58	-	-	-	1346	-	145	30	1465	-	1482	16	14,2																				
1600	1930	1820	56	40	M52	1626,0	-	-	-	-	58	64	-	-	-	1546	-	160	35	1668	-	1696	16	16,0																				
1800	2130	2020	56	44	M52	1829,0	-	-	-	-	62	68	-	-	-	1746	-	170	35	1870	-	1896	16	17,5																				
2000	2345	2230	62	48	M56	2032,0	-	-	-	-	66	70	-	-	-	1950	-	180	40	2072	-	2100	16	20,0																				

\* For flanges type 21 the outside hub diameter approximately corresponds to the outside pipe diameter,

\*\* 8 holes is preferred however 4 holes may be supplied upon special request by the purchaser.

**NOTE:** The p/t ratings from EN 1092-1 apply only for flange types 05, 11, 12, 13 and 21 having nominal sizes up to and including DN 600. The p/t rating of all other flanges shall be agreed between the manufacturer and the purchaser.